

CERBACO LTD.









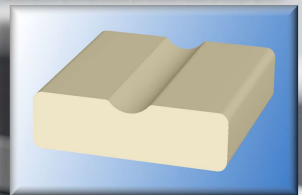
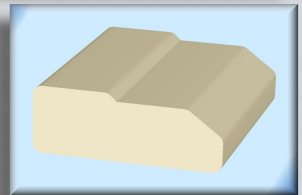
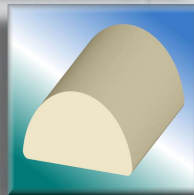
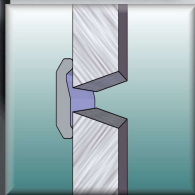
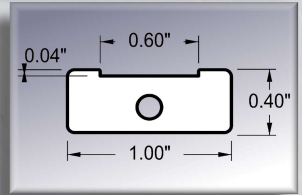
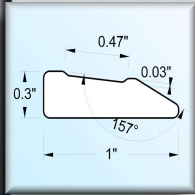
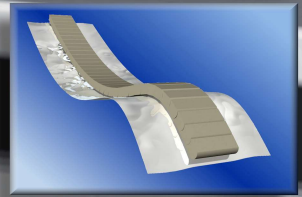
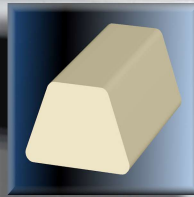
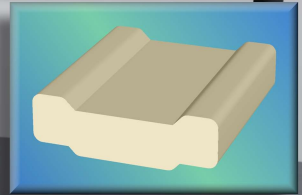
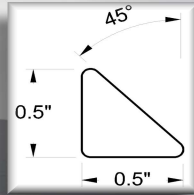
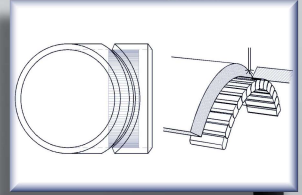









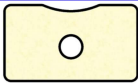







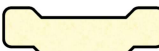

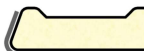
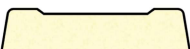

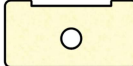

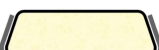

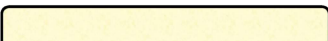



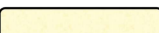



WELD BACKINGS

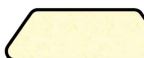

MADE IN U.S.A.

WWW.CERBACO.COM



 1C32-CE	 1C41-CE	 1C42-CE	 1C42-D
 1C42-DT	 1C43-CE	 1C43-DT	 1C44-CE
 1C44-W	 1C46-A	 1C52-CE	 1C72
 1C72-A	 1C75	 1C83	 1C85
 1B92-A	 1B93-A	 1B93-A-40mm	 1B93-A-DT
 1B93-CDT	 1B93-20	 1B93-W	 1C42-FL
 1C42-FL-DT	 1C42-FL-1/4"	 2 X 2 X 3/8"	
 1C42-EZ	 1C42-EZ-1/4"	 2 X 2 X EZ	
 1C90	 1C33-45	 1C33-60	 1C33-90
 1C45	 1C54	 1C55	 1S14
 105 DEG.	 145 DEG.	 1N34	 1N35
 1S60	 D13-8mm	 D13-12mm	 D13-20mm RD/2

JUST A FEW OF OUR 500+ PROFILES

At CERBACO, we will provide you with the proper backing for your applications.

Our engineers will be happy to assist you in implementing the proper weld backing.

CERBACO can also develop new backings and formulations for your specific needs.

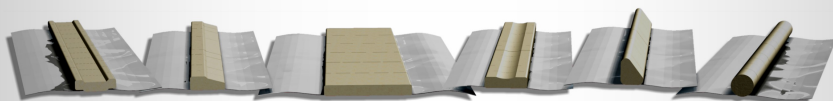

With a full range of shapes, formulations and mounting systems combined with our 25 years of expertise and customization, CERBACO LTD. is the one source for weld backings.

*CERBACO LTD.
2068 BUNNELL RD.
WARRINGTON, PA. 18976
PHONE: 908-996-1333
FAX: 908-996-0023*

www.cerbaco.com

PRODUCT DESCRIPTION

In the past, full penetration welding involved costly backgouging, grinding, and rewelding. With CERBACO LTD. non metallic weld backings you can achieve X-ray quality, full-penetration welds from one side and in a single pass. The result is a finished high quality weld and a savings of labor, materials, and time. CERBACO weld backings are manufactured in many different configurations and in formulas for the diverse conditions encountered when welding anything from light gauge sheet metal to heavy metal fabrication. CERBACO weld backings can be used to compensate for poor fit-ups, and is a valuable tool when welding conditions are not ideal or where the back side of a weld joint is inaccessible.

CERBACO weld backings are non metallic, non hygroscopic, neutral, and unlike metal backing bars, do not become part of the finished weld. When properly positioned and attached to the back side of a weld joint, your welds can be free of defects eliminating rework and cleanup associated with poor root welds.

One-sided one-pass and one-sided multi-pass welds are possible with CERBACO weld backings. Our backings support molten weld metal over a wide range of welding heats resulting in uniform back beads of finished quality.

SERVICES

At CERBACO, we will provide complete technical assistance and will direct proper use of our products. If your application requires something special we will design custom shapes and sizes. In addition we will, if necessary, develop new backing formulations for you. In our 25 years of experience we have designed over 500 profiles. Typically, we stock many of these items in order to be ready for immediate shipment. All manufacturing is done by CERBACO. When an item is not readily available, it can generally be shipped within days from the time of order.

STEP 1. START WITH AN OPEN ROOT:

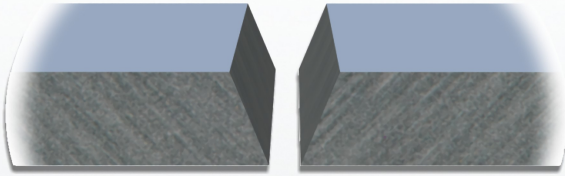

STEP 2. APPLY BACKING:

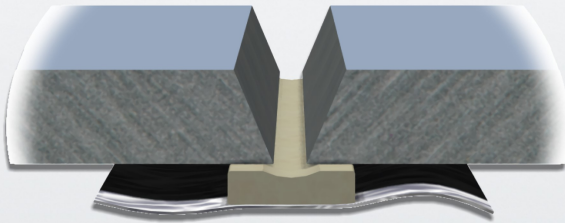

STEP 3. WELD:

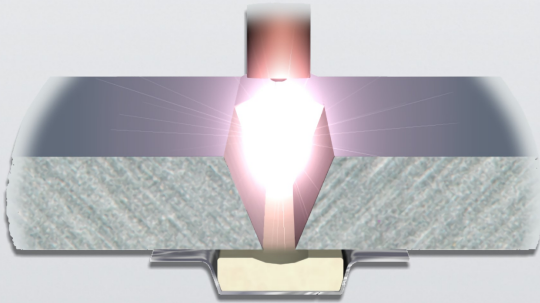

**STEP 4. REMOVE BACKING TO REVEAL
FINISHED BACKBEAD**

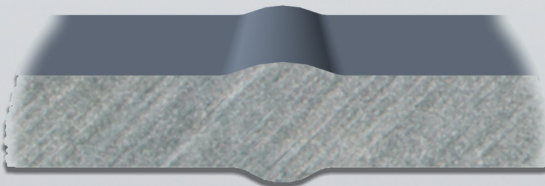

1C41-CE

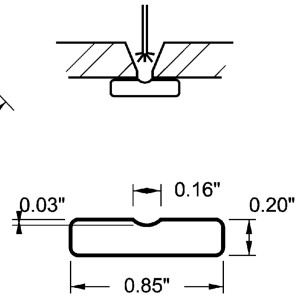
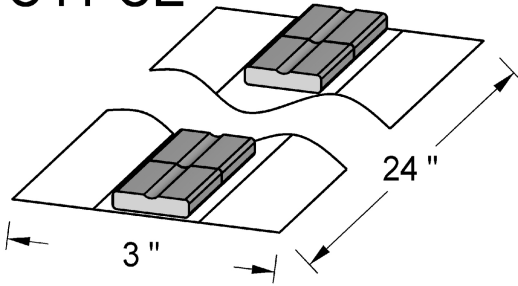

1C42-CE

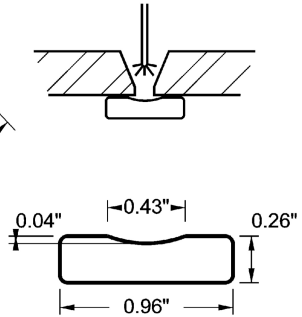
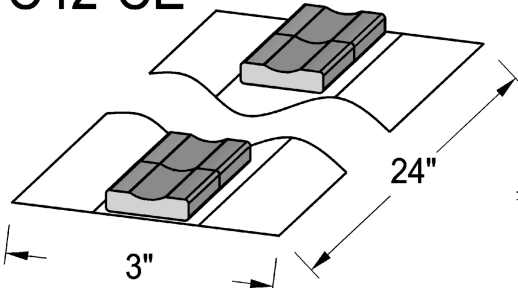

1C43-CE

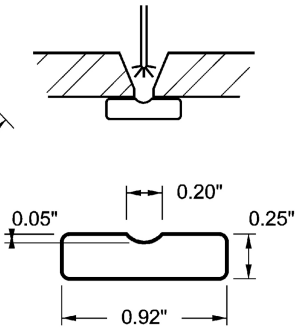
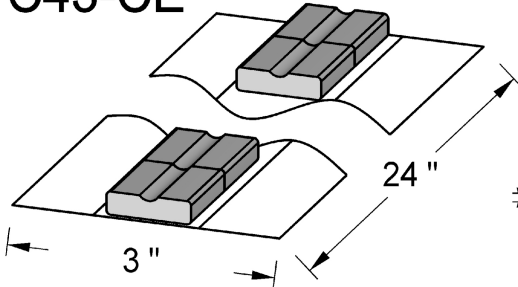

1C44-CE

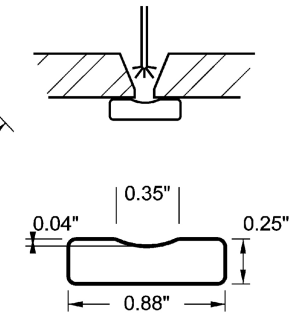
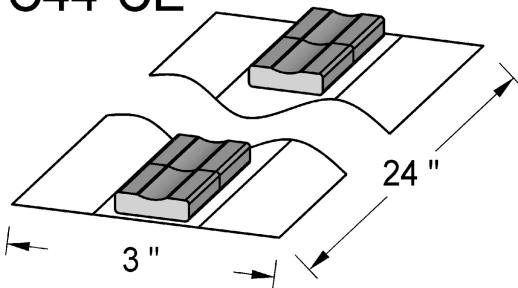

1C44-W

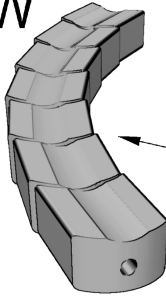

6" RAD.

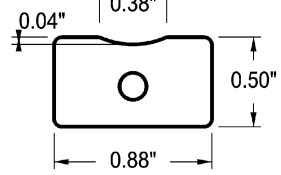
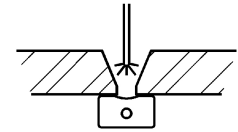

1C52-CE

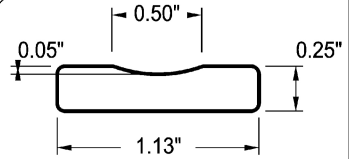
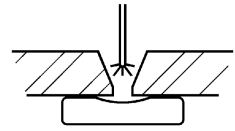
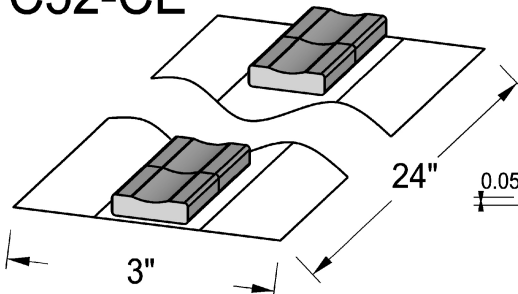

1C72

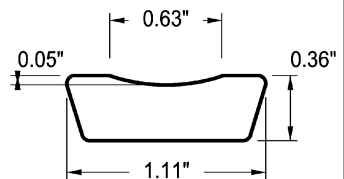
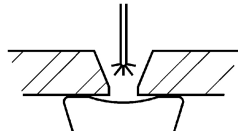
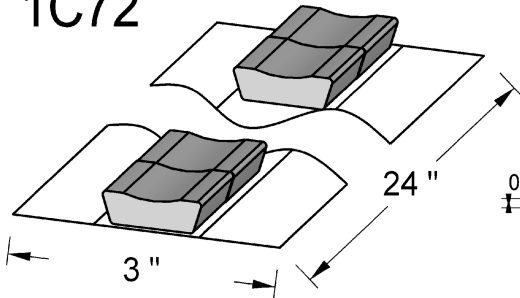

1C82-CE

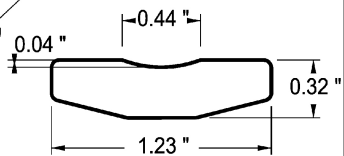
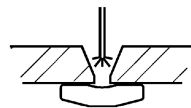
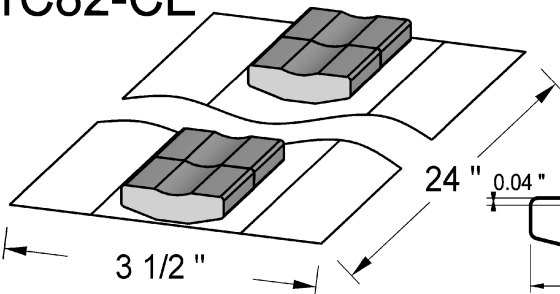

1C83-CE

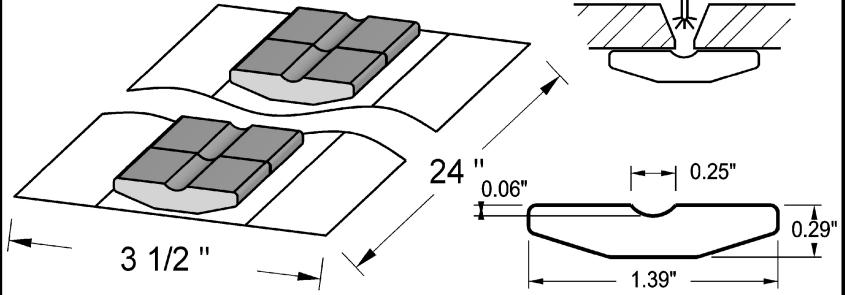

1C85

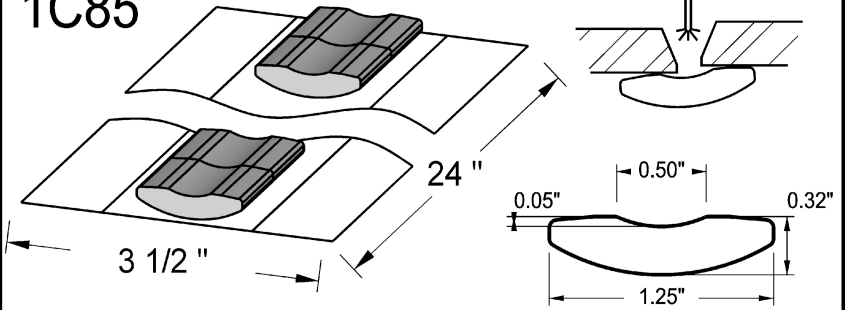

1B92-A

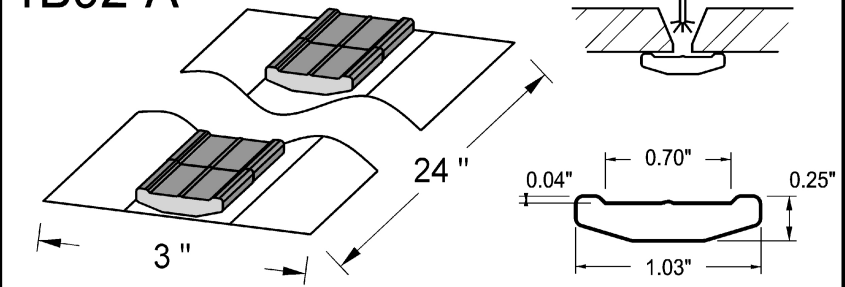

1B93-A

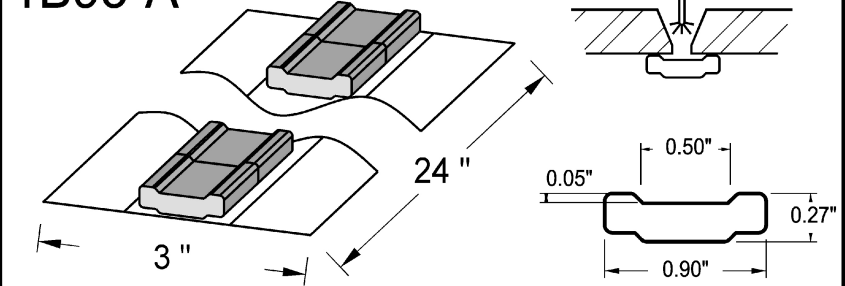

1B93-CDT

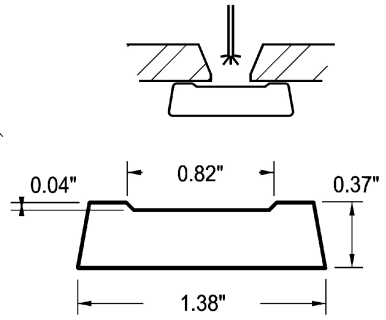
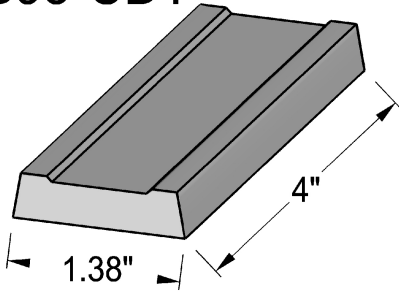

1B93-W

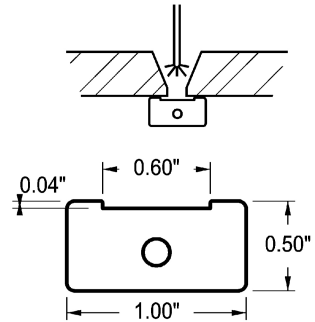
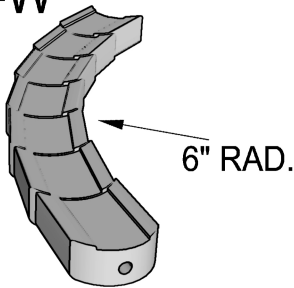

1C42-FL

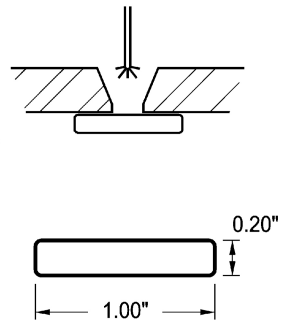
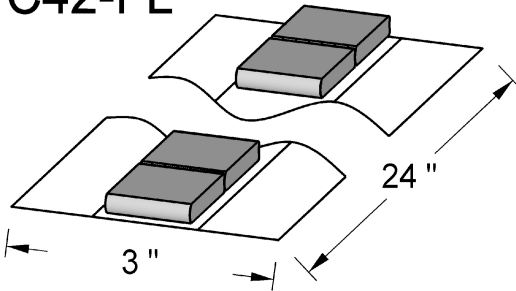

1C42-FL-1/4"

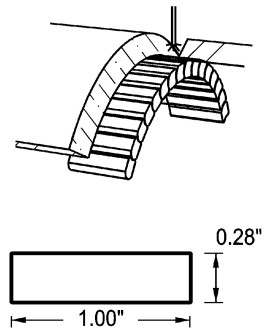
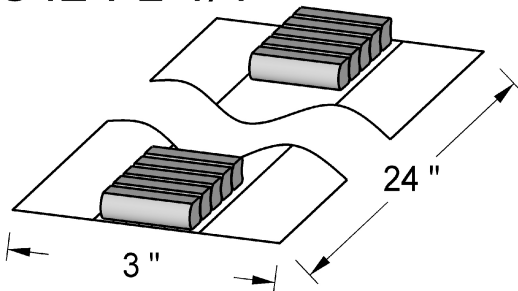

2 X 2

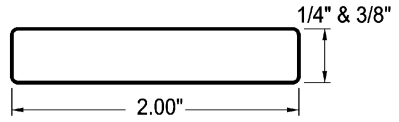
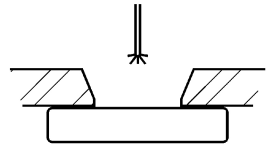
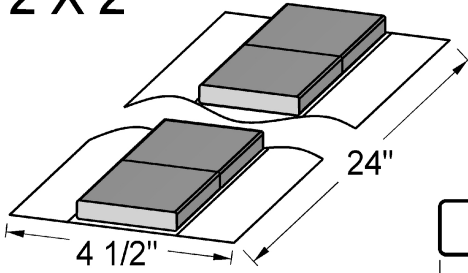

1C33-45

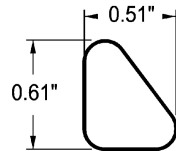
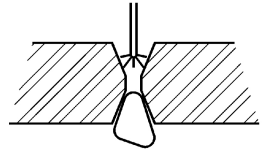
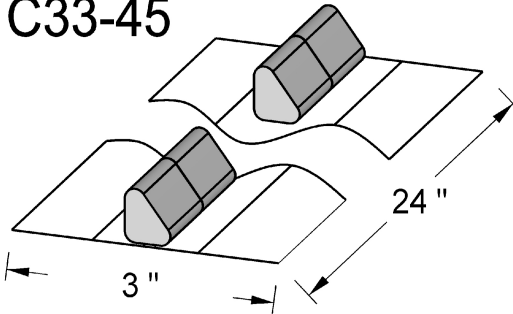

1C33-60

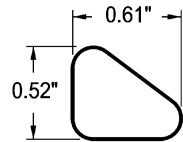
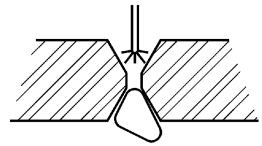
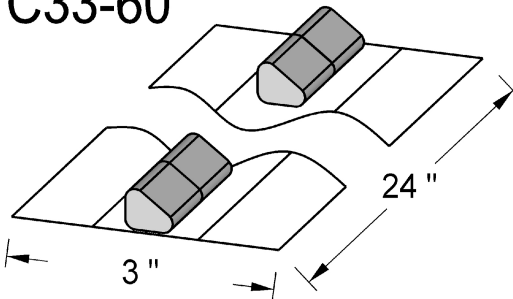

1C33-90

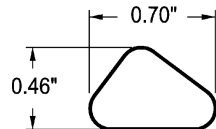
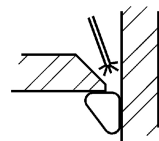
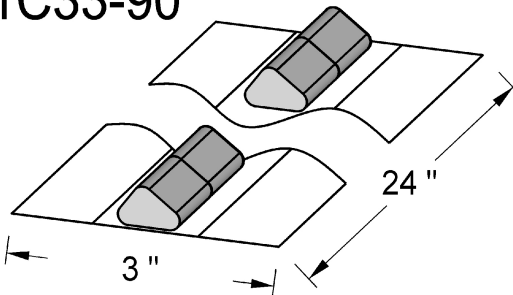

1C54

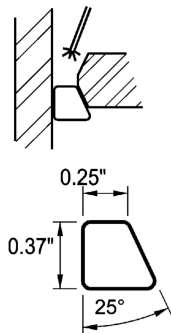
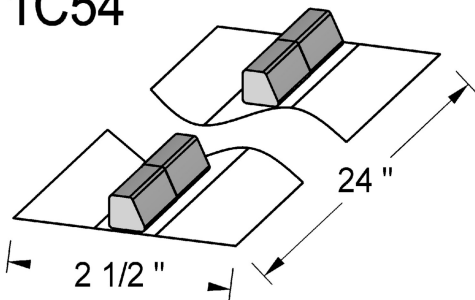

1C50

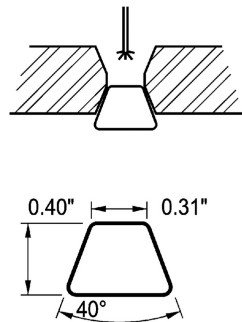
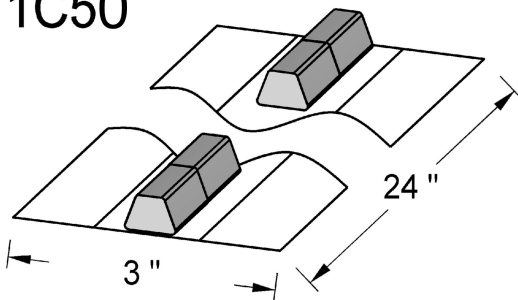

1S14

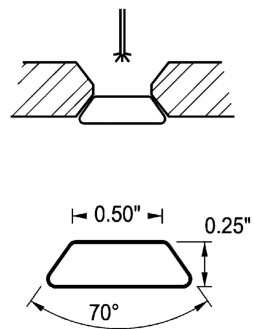
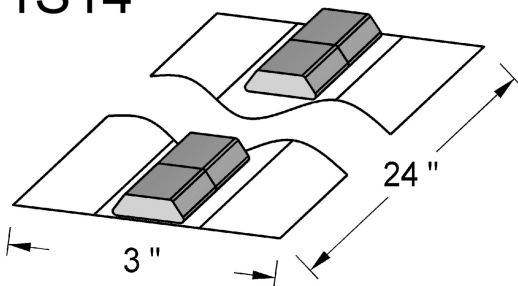

145 Deg.

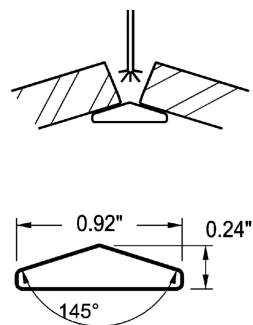
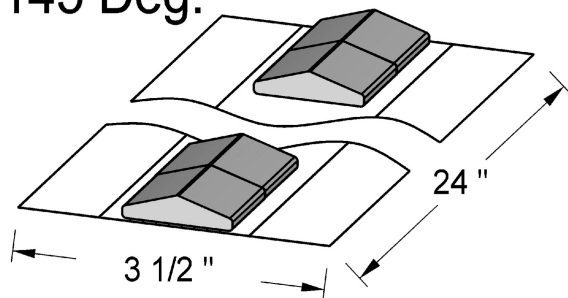

1N34

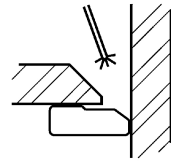
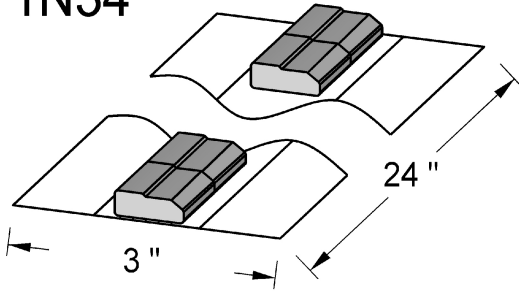

1N35

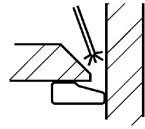
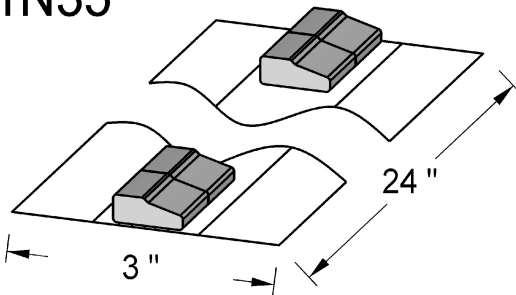

D13-(7mm to 16mm)

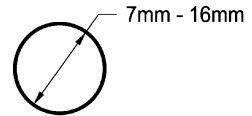
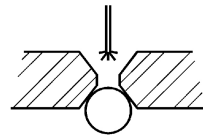
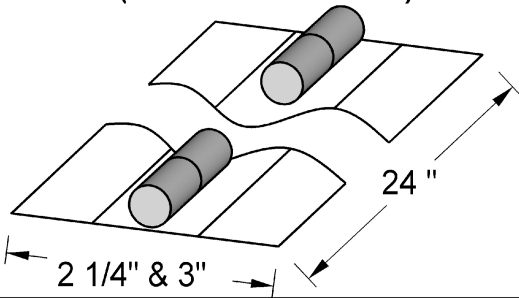

D13-(12mm to 20mm) RD/2

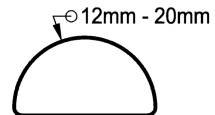
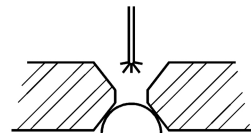
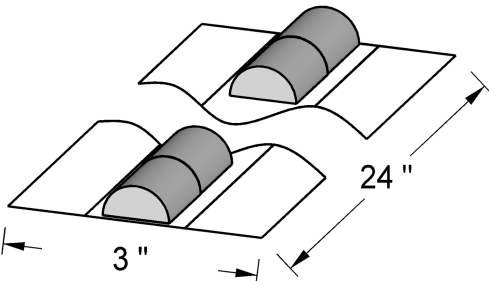

CERBACO can also supply you with dimensional copper weld backing in a variety of RWMA alloys.



CERBACO also manufactures a line of flexible fiber backings for TIG welding of carbon and stainless sheet metal.

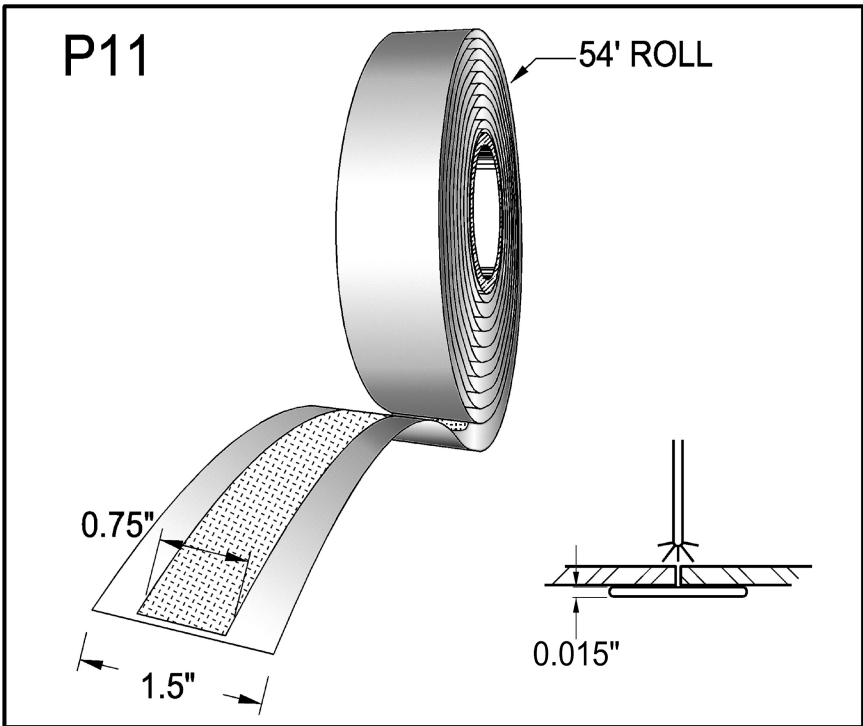

P4

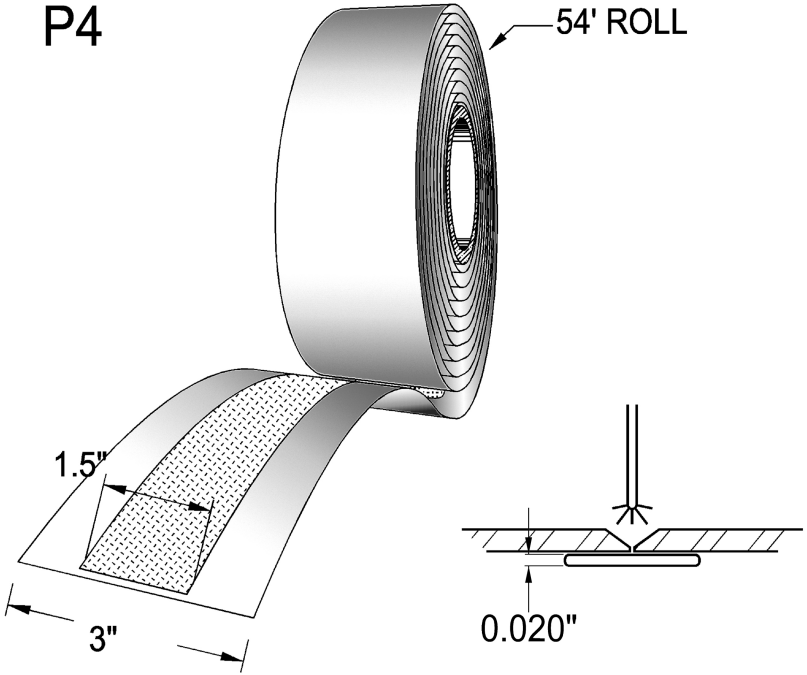

.062 HDT
.125 HDT
.250 HDT

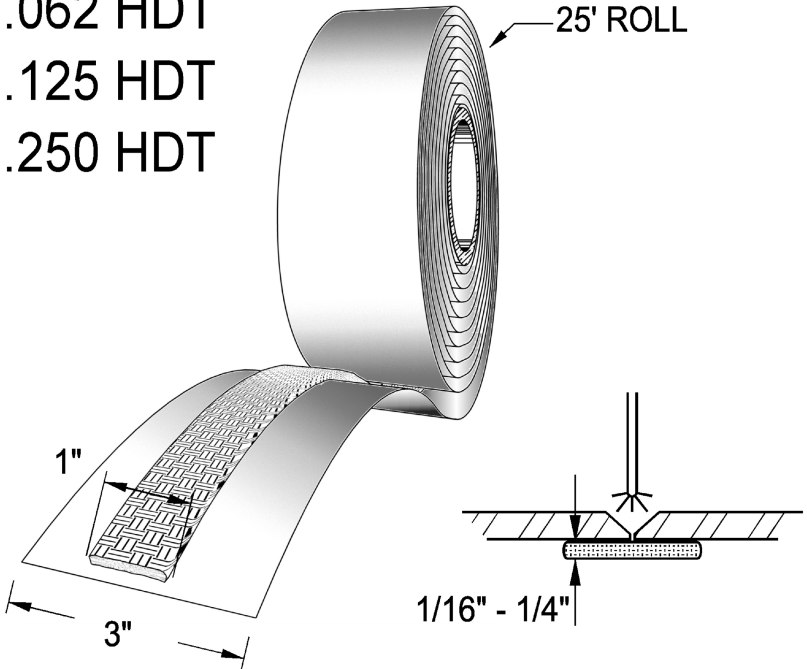

CERBACO LTD.

NON METALLIC WELD BACKINGS

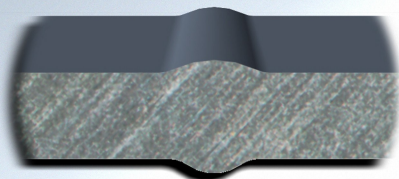
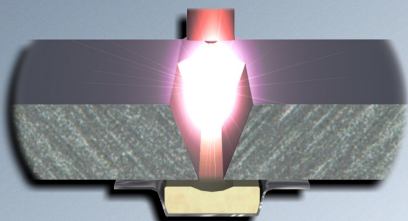

FROM THIS

TO THIS

**WITHOUT GOUGING, GRINDING,
REWELDING OR REWORK**

**WHETHER YOU'RE WELDING SHIPS, PRESSURE VESSELS,
PIPE, TANKS, OR STRUCTURAL STEEL, WE CAN HELP YOU**

WELD MORE EFFICIENTLY

**CERBACO WELD BACKINGS LET YOU ACHIEVE
X-RAY QUALITY FULL PENETRATION WELDS**

**WITH OUR EXTENSIVE LINE OF BACKING MATERIALS AND
OUR SEASONED ABILITY FOR CUSTOMIZATION,
CERBACO IS THE ONE SOURCE FOR
WELD BACKINGS.**



MADE IN USA

PHONE: 908-996-1333

WWW.CERBACO.COM

FAX: 908-996-0023

SALES@CERBACO.COM

CERBACO



LTD.

At CERBACO, we will provide you with the proper backing for your applications.

Our engineers will be happy to assist you in implementing the proper weld backing.

CERBACO can also develop new backings and formulations for your specific needs.

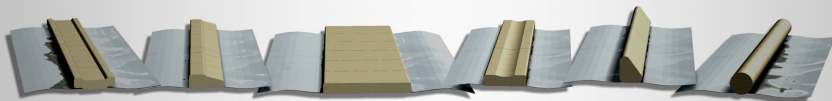

With a full range of shapes, formulations and mounting systems combined with our 25 years of expertise and customization, CERBACO LTD. is the one source for weld backings.

CERBACO LTD.
2068 BUNNELL RD.
WARRINGTON, PA. 18976

PHONE: 908-996-1333
FAX: 908-996-0023

WWW.CERBACO.COM

CERBACO LTD.
2068 BUNNELL ROAD
WARRINGTON, PA 18976

TEL: 908-996-1333
FAX: 908-996-0023

WELD BACKING REQUIREMENTS

SUBMITTED BY: _____ TITLE: _____
COMPANY: _____
ADDRESS: _____
CITY, STATE, ZIP: _____
TEL: _____ FAX: _____ E-MAIL: _____

PLEASE PROVIDE US WITH THE FOLLOWING INFORMATION

BASE MATERIAL _____ THICKNESS _____
JOINT DESIGN _____ ROOT OPENING _____
BEVEL ANGLE _____ WELDING PROCESS _____
LAND SIZE _____
ELECTRODE/WIRE TYPE & DIAMETER _____
VOLTS _____ AMPS _____ TRAVEL SPEED _____
WELD POSITION FLAT HORIZONTAL VERTICAL
CIRCUMFERENTIAL YES NO IF YES DIAMETER _____

SPECIAL REQUIREMENTS (PROVIDE SKETCH IF NECESSARY)

BEFORE USING, USER SHALL DETERMINE ULTIMATE SUITABILITY OF THE PRODUCT FOR ITS INTENDED USE AND ASSUME ALL RISK AND LIABILITY
SELLER AND MANUFACTURERS' OBLIGATION SHALL BE LIMITED TO REPLACE THE QUANTITY OF THE PRODUCT PROVED TO BE DEFECTIVE.
SELLER AND MANUFACTURER SHALL NOT BE LIABLE FOR INJURY, LOSS OR DAMAGE ARISING OUT OF USE OR MISUSE OF THIS PRODUCT.